

## Superficie Surface

Star 36

# ST36

Perfil de superficie.  
Fabricado con aluminio extrusionado y anodizado.  
Diseñado como disipador de tiras de LED.

Surface profile.  
Made of extruded and anodized aluminium.  
Designed to dissipate LED strips.



### Características técnicas

Technical data

Potencia disipada Power dissipation	Máx. 60W/m
Aleación de aluminio Aluminium alloy	AL6060
Longitud Length	2m <sup>(1)</sup>
IP	20
Acabado Finish	Anodizado Anodized / Pintado Painted

<sup>(1)</sup> Otras medidas disponibles. Máximo 6m. Other sizes available. Maximum 6m.

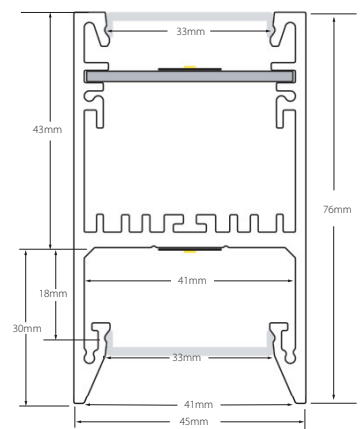

**2100450**  
Transparente  
Clear  
**80° / 80°**  
**-0% lm**

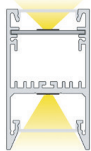

**2100451**  
Mate  
Medium frosted  
**80° / 80°**  
**-40% lm**

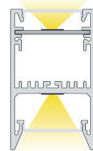

**2100402**  
Negro  
Black  
**80° / 80°**  
**-60% lm**

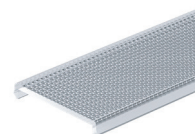
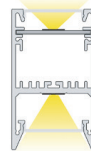

**2100451**  
Microprismático transparente  
Clear microprismatic  
**80° / 80°**  
**-25% lm**



**210041007**  
Pletina de superficie  
Aluminium plate



**210041007**  
Tapa ciega de aluminio  
Aluminium cover cap



**233013073**  
Aleta para pladur 2pcs.  
Plasterboard flap 2pcs.

Incluye tornillos  
Screws included



**220570007**  
Tapa final aluminio  
Aluminium end cap



**231035070**  
Clip de sujeción  
Mounting bracket

Incluye tornillos  
Screws included



**2410150**  
Pieza de unión  
Joining piece



### Superficie Surface

#### Star 36



**2410151**  
Pieza unión 90°  
Union piece



**2410021**  
Pieza unión int o ext.  
90° union piece int or ext.



**2441001401702**  
Adhesivo fuga de luz  
Light leak adhesive

Screws and light leak adhesive included  
Screws and light leak adhesive included

Referencia Reference	Descripción Description	Acabado Finish	Color Color
ST36-A	Perfil superficie aluminio Aluminium surface profile	Anodizado Anodized	● Plata mate Matt silver
ST36-B	Perfil superficie aluminio Aluminium surface profile	Pintado Painted	○ Blanco White
ST36-N	Perfil superficie aluminio Aluminium surface profile	Anodizado Anodized	● Negro Black

### Accesorios Accessories

Referencia Reference	Descripción Description	Acabado / Color Finish / Color
25300240007	Pletina de superficie en aluminio Aluminium surface plate	Plata mate Matt silver
2100450	Difusor policarbonato Polycarbonate diffuser	Transparente Clear Mate Medium frosted
2100402	Difusor metacrilato Methacrylate diffuser	Negro Black
2100460	Difusor microprismático Microprismatic diffuser	Transparente Clear
210041007		Plata mate Matt silver
210041001	Tapa ciega aluminio Aluminium cover cap	Blanco White
210041002		Negro Black
233013073	Aleta para pladur, 2 piezas, 1 juego Plasterboard flap, 2 pcs., 1 set	Plata mate Matt silver
220570007		Plata mate Matt silver
220570001	Tapa final aluminio Aluminium end cap	Blanco White
220570002		Negro Black
231035070	Clip de sujeción metálico Metal mounting bracket	Zincado Zinc
2410150	Pieza de unión metálica Metal joining piece*	Metalico Galvanized
2410151	Pieza de unión a 90° metálica Metal 90° joining piece*	Metalico Galvanized
2410152	Pieza de unión a 90° metálica interior o exterior Metal internal or external 90° joining piece*	Metalico Galvanized
2441001401702	Adhesivo fuga de luz Light leak adhesive*	Negro Black

\*Incluye tornillos y adhesivo fuga de luz

Para la instalación con iluminación por los 2 lados, se necesitan 2 difusores 2 diffusers are required for installation with illumination from both sides



## Superficie Surface

Star 36

### Instalación Facility

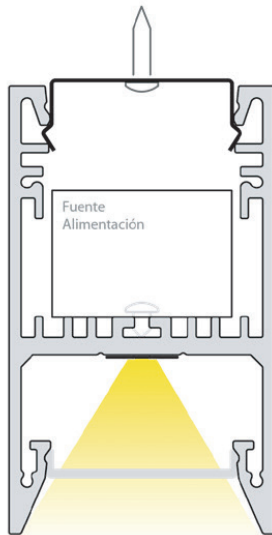

Fijación con clip + fuente alimentación / Clip fastener + power supply / Clip de fixation + alimentation

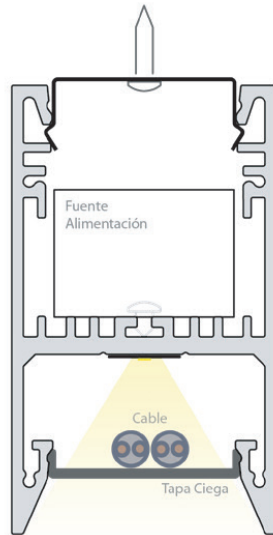

Fijación con clip + fuente alimentación + cableado / Clip fastener + power supply + cabling / Clip de fixation + alimentation + câblage

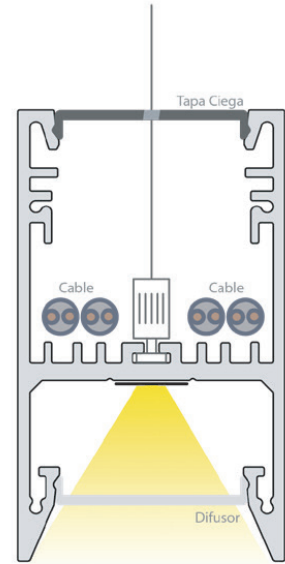

Fijación con tensor + tapa ciega / Fastener with tensioner + solid cover / Fixation avec tendeur + cache aveugle

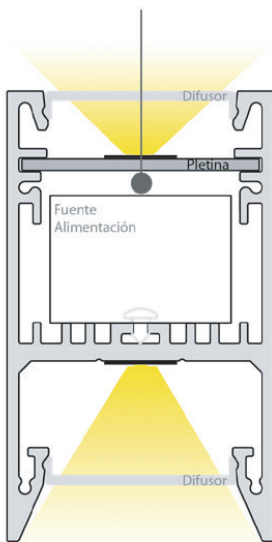

Fijación con tensor + doble difusor (up & down) / Fastener with tensioner + double diffuser (up & down) / Fixation avec tendeur + double diffuseur (haut & bas)

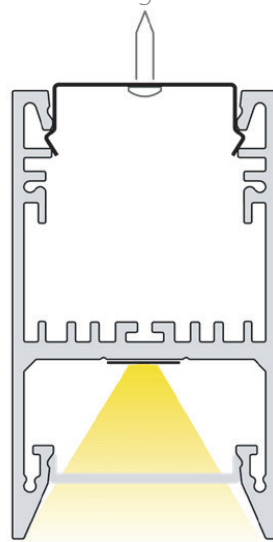

Fijación con clip / Fastener with tensioner + clip fastener / Fixation par clip

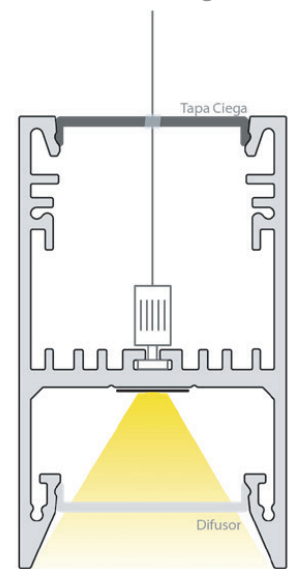

Fijación con tensor / Fixing with tensioner / Fixation avec tendeur



## Superficie Surface

Star 36



### Advertencias Warnings

- Si la superficie donde va colocada la tira de LED tiene residuos, asegúrese de limpiarla hasta que quede libre de ellos.
- No utilizar este perfil para LEDs superiores a la potencia indicada, ya que no se podría garantizar la vida útil del LED.
- No utilice cola o silicona para fijar el perfil sin antes asegurar que la posición funcional es la correcta.
- If the surface where the LED strip is located has debris, be sure to clean it until it is free of them.
- Not use this profile to LED above the indicated power because it could not guarantee the life of the LED.
- Do not use glue or silicone to set the profile if before ensuring that the functional position is correct.

