



Tira de LEDs flexible de alta calidad lumínica. Especialmente desarrollada para iluminar frutas y verduras. Se consigue una buena uniformidad gracias a la pequeña separación entre los LEDs.

High quality light flex LED strip. Specially developed to illuminate fruits and vegetables. Good uniformity is achieved thanks to the small separation between the LEDs.

5
Años
Garantía

19,2
W/m

LED SMD
3528

A⁺

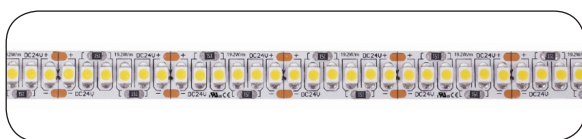

Referencia <i>Reference</i>	CCT (K)	Lumens/m	Lumens/W	Eficiencia energética <i>Energy efficiency</i>
FRE-19,2-40-24	4000	1775	92	A ⁺

Características técnicas / Technical data

Potencia / Power	19,2W
Potencia rollo / Roll Power	96W
IP	20
Voltaje / Voltage	24V
Tipo de LED / LED type	3528
LEDs/m	240
Pitch	4,17mm
Ángulo / Beam angle	120°
Longitud mín. corte / Min. cutting length	25mm
Longitud rollo / Roll length	5m
Vida útil / Life time	50.000h
Temperatura ambiente / Ambient temperature	-20~50°C
Temperatura almacenamiento / Storage temperature	-40~80°C
Marca punto Tc / Tc point mark	Sí / Yes ⁽¹⁾
Años de garantía / Warranty years	5
Regulable / Dimmable	Sí / Yes
Necesita disipador / Needs heatsink	Sí / Yes
Longitud máx. / Max. length	10m ⁽²⁾

(1) (UNE-EN 60598-1:2015; UNE-EN 60598-2-1:1993)

(2) Conectadas en serie / Connected in series

3 pasos MacAdams 3 MacAdams steps

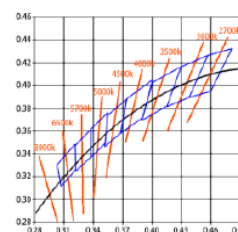

CDL

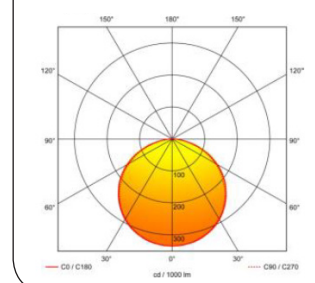

24V



Lluria se reserva el derecho de modificar las especificaciones.
Lluria reserves the right to modify specifications.

1/3
v.2018.00

• **Medidas / Dimensions**

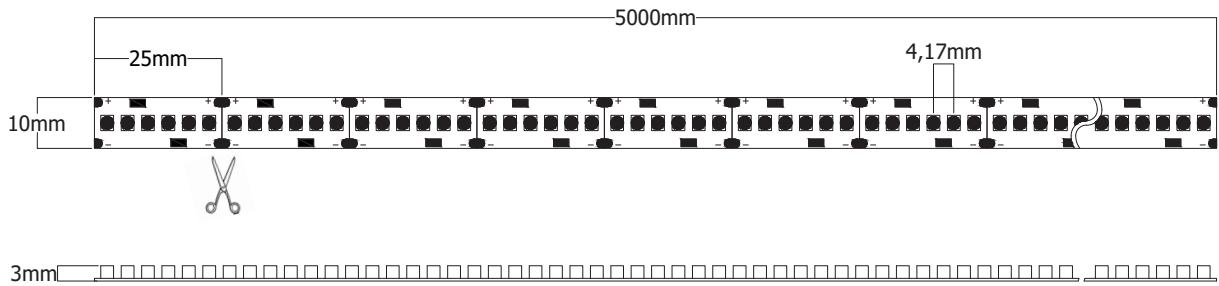

• **Esquema conexión / Circuit diagram**

Respete las longitudes máximas para evitar caídas de tensión y variaciones en la intensidad lumínica.

Respect the maximum lengths to avoid drops voltage and variations in light intensity.

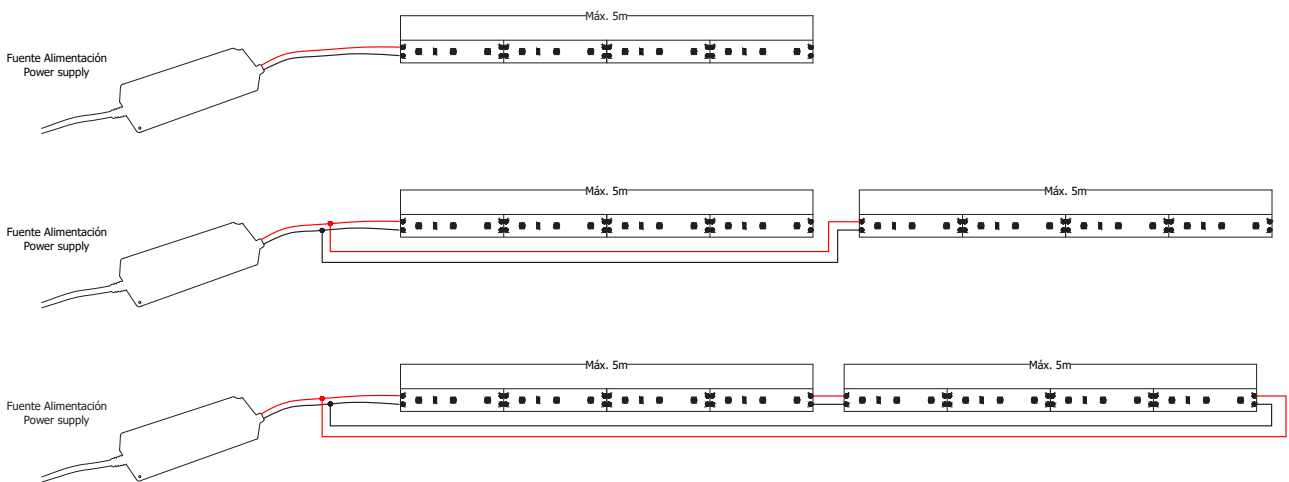

• **Sección cable / Cable section**

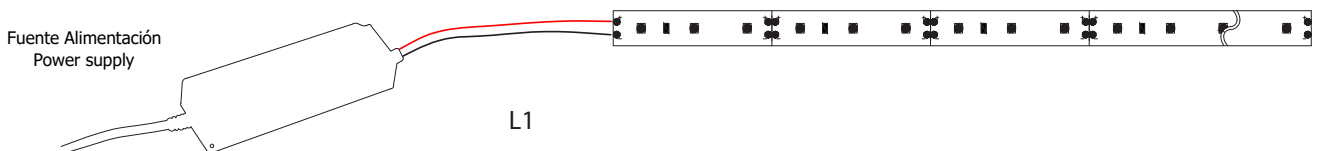

	L1		
Distancia/ Distance	≤5m	≤15m	≤25m
Sección/ Section	1.5mm ²	2.5mm ²	4mm ²

• **Detalle de montaje / Assembly detail**

No doble la tira de LED para adaptarla a radios o ángulos pronunciados, corte por la marca y suelde un tramo de cable para poder realizar el giro.

Do not bend de LED strip to adapt them to sharp radius or angle, cut for the cut mark and weld a section of cable to make the turn.

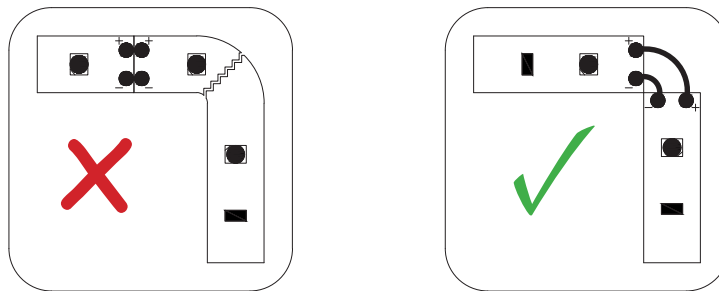

• **Vida útil / Life time**

La vida útil de nuestros LEDs es de 50.000h a una temperatura ambiente de 23°C y provistos de un sistema de disipación de calor. Se recomiendan ciclos de apagado para alargar la vida de los LEDs.

The life time of our LEDs is 50.000h at an ambient temperature of 23°C and provided with a heat dissipation system. Off cycles are recommended to extend the life of the LEDs.

 **Advertencias / Warnings**

Con el fin de garantizar la vida del LED, es obligatorio colocarlo sobre una superficie que disipe el calor que generan. Vigile al manipular los cables para evitar daños en las soldaduras.

Los picos de tensión pueden causar daños.

Si se utiliza difusor con el perfil disipador, puede haber variaciones en la temperatura de color.

To ensure the life of the LED, it is request to place on a surface that dissipates the heat they generate.

Caution when handling cables to avoid damage to the welds.

The voltage surges can cause damage.

If diffuser is used with the dissipating profile, there may be variations in the color temperature.