

Inside IP20

Nature 28,8W/m Double White

NA28,8 DW

Tira de LED flexible que emula la calidad lumínica del sol. Se caracteriza por tener el índice de fidelidad cromática muy alto y por su capacidad de reproducir colores con un nivel de saturación muy parecido al del sol. Para uso interno.

Flexible LED strip that emulates the light quality of the sun. It is characterized by having a very high color Fidelity index and its capacidad of reproducing colors with a saturation level very similar to the sun. For internal use.

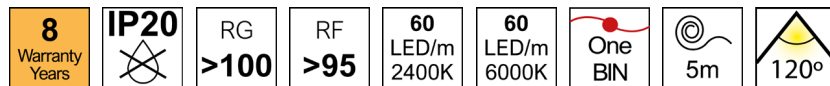

Referencia Reference	CCT	Lumens /m	Lumens /W
NA28,8-24-60	● 2400K	1070	75
	● 6000K	1337	94

Características técnicas

Technical data

Potencia Power	28,8W/m
Potencia rollo 5m Roll power 5m	144W
IP	20
Rf	>95
Rg	>100
CRI	>98
R9	>90
Voltaje Voltage	24V
Tipo de LED LED type	2835
LEDs/m (2400K)	60
LEDs/m (6000K)	60
Pitch	16,7mm
Ángulo Beam angle	120°
Longitud mín. corte Min. cutting length	100mm
Longitud rollo Roll length	5m
Vida útil Life time	50.000h
Temperatura ambiente Ambient temperature	-20~50°C
Temperatura almacenamiento Storage temperature	-40~80°C
Años de garantía Warranty years	8
Regulable Dimmable	Sí Yes
Necesita disipador Needs heatsink	Sí Yes
Longitud máx. Max. length	6m ⁽¹⁾

⁽¹⁾ Conectadas en serie Connected in series

3 Pasos MacAdam 3 MacAdam steps

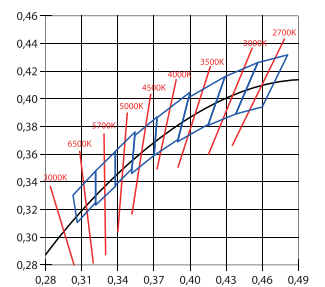

CDL

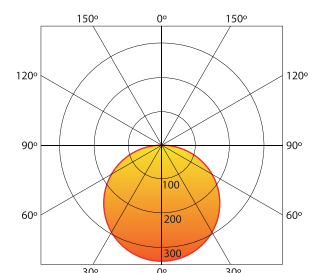

Inside IP20

Nature 28,8W/m Double White

Medidas LED

- LED dimensions

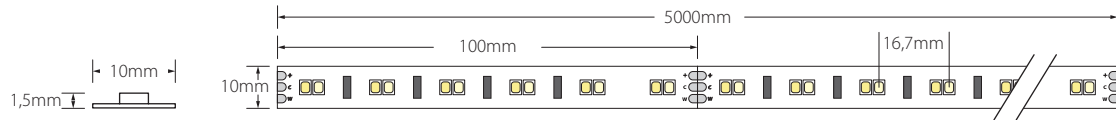

Esquema de conexión

- Circuit diagram

Respete las longitudes máximas para evitar caídas de tensión y variaciones en la intensidad lumínica.
Respect the maximum lengths to avoid drops voltage and variations in light intensity.

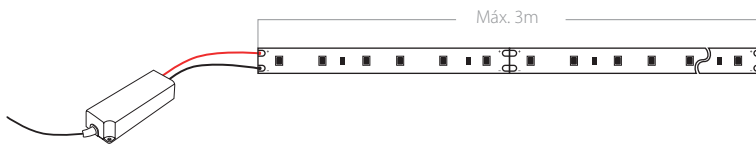

Fuente de alimentación
Power supply

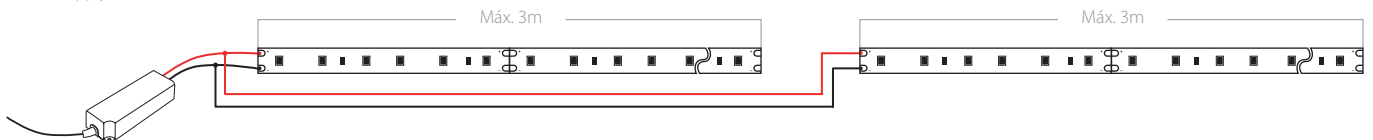

Fuente de alimentación
Power supply

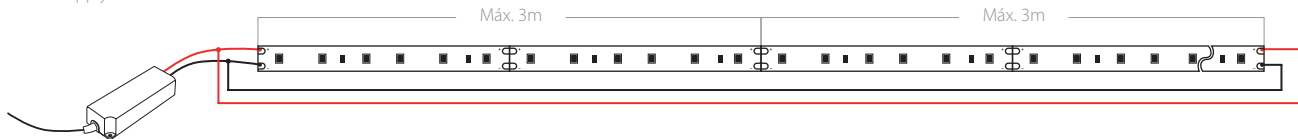

Fuente de alimentación
Power supply

Sección cable

- Cable section

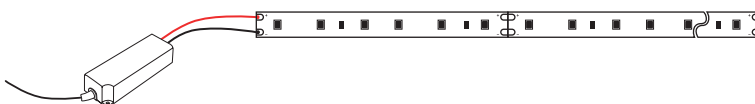

Fuente de alimentación
Power supply

	Cable		
Distancia Distance	≤ 5m	< 15m	< 25m
Sección Section	0,75mm ²	2,5mm ²	4mm ²



Inside IP20

Nature 28,8W/m Double White

Distancia LED- Perfil

Distance LED- Profile

Distancia mínima que se debe dejar en los extremos, ambos lados, entre tira de LED y perfil.

Minimum distance that should be left at the ends, both sides, between LED strip and profile.

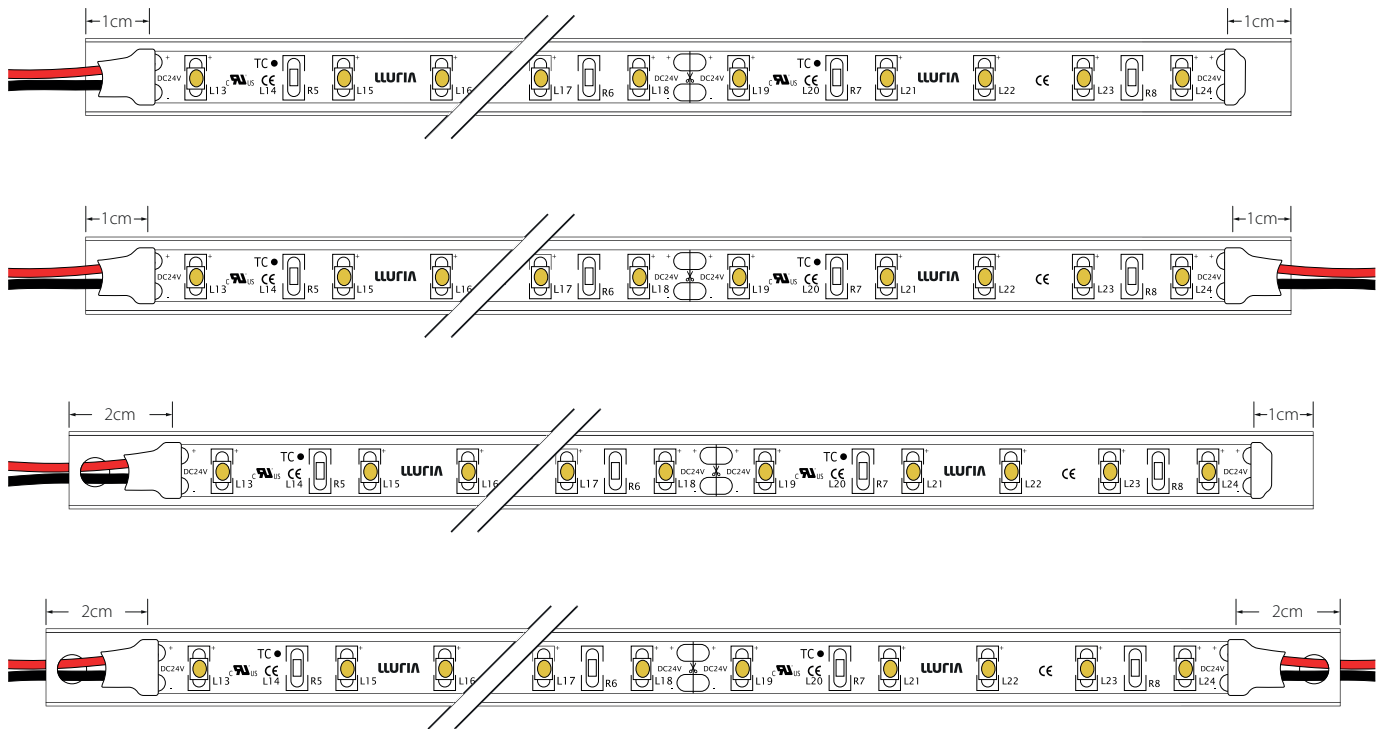

Detalle de montaje

Assembly detail

No doble la tira de LED para adaptarla a radios o ángulos pronunciados, corte por la marca y suelde un tramo de cable para poder realizar el giro.

Do not bend de LED strip to adapt them to sharp radius or angle, cut for the cut mark and weld a section of cable to make the turn.

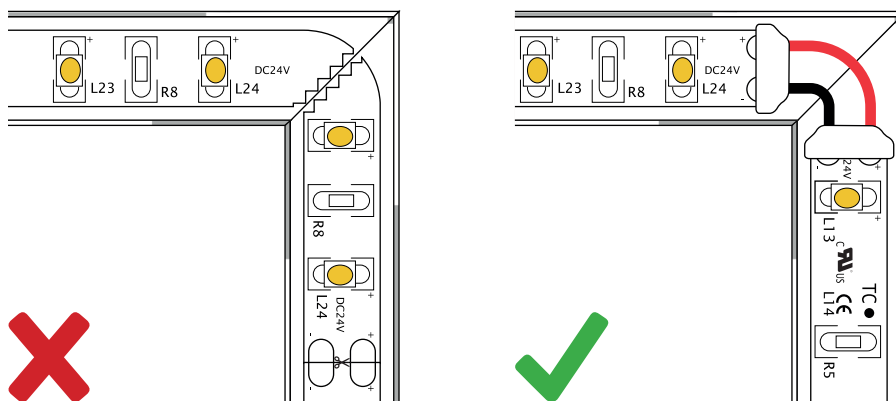

Inside IP20

Nature 28,8W/m Double White

- Vida útil**
Life time

La vida útil de nuestros LEDs es de 50.000h a una temperatura ambiente de 23°C y provistos de un sistema de disipación de calor. Se recomiendan ciclos de apagado para alargar la vida de los LEDs.
The life time of our LEDs is 50.000h at an ambient temperature of 23°C and provided with a heat dissipation system. Off cycles are recommended to extend the life of the LEDs.



Advertencias Warnings

- Con el fin de garantizar la vida del LED, es obligatorio colocarlo sobre una superficie que disipe el calor que generan.
- Vigile al manipular los cables para evitar daños en las soldaduras.
- Los picos de tensión pueden causar daños.
- Si se utiliza difusor con el perfil disipador, puede haber variaciones en la temperatura de color.
- To ensure the life of the LED, it is request to place on a surface that dissipates the heat they generate.
- Caution when handling cables to avoid damage to the welds.
- The voltage surges can cause damage.
- If diffuser is used with the dissipating profile, there may be variations in the color temperature.

